

BT50 60 Degree Pull Stud

Part Number: BT506



SPECIFICATIONS

Taper: BT50
Angle: 60°

SHIPPING WEIGHT: 0.32 Kg

FEATURES

- Material: SNCM 21
- Hardness: HRC 54
- MAS403

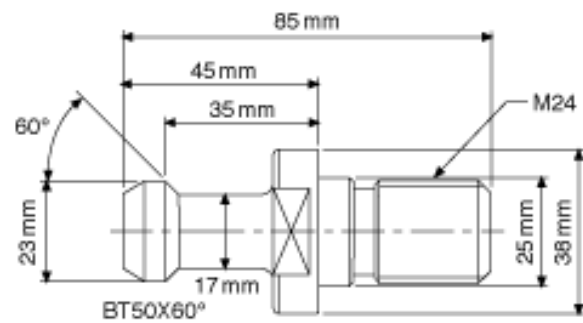

Part Number	Description	Material	Hardness	Weight
BT506	BT50 60 Degree Pull Stud	SNCM 21	HRC 54	0.32 Kg